

<h1>汽车继电器</h1>	<h1>TRKP</h1>
----------------	---------------

- 40A continuous rating 85°C
- PC board terminals
- Inrush current 100A
- Open & sealed version available
- Conform to ROHS, ELV directive



### ■ ORDERING CODE 订购代码

<u>TRKP</u> <u>L</u> — <u>S</u> — <u>Z</u> <u>1</u> / 12VDC 1      2      3      4      5      6	
1. Relay Model 继电器型号 2. Coil Power 线圈功率 D=1.9W, L=1.6W 3. S: Sealed 密封 Nil: open type 敞开型 4. 触点转换形式 Z: Form C H: Form A	5. 1: USA type 2. EUROPE type 6. Coil Nominal Voltage 线圈额定电压 3,5,6,9,12,24VDC

### ■ COIL DATA 线圈参数 (at 20°C)

Nominal Voltage 额定电压(VDC)	3	5	6	9	12	24	1.6W
Coil Resistance 线圈阻值(Ω ±10%)	6	16	23	50	90	360	
Rated Current 额定电流(mA)	533	320	267	178	133	67	
Max Operate Voltage 最大吸合电压(VDC)	1.95	3.25	3.9	5.85	7.8	15.6	
Min Release Voltage 最小释放电压(VDC)	0.3	0.5	0.6	0.9	1.2	2.4	
Coil Resistance 线圈阻值(Ω ±10%)	5	13	19	43	76	300	1.9W
Rated Current 额定电流(mA)	633	380	317	211	158	79	
Max Operate Voltage 最大吸合电压(VDC)	1.95	3.25	3.9	5.85	7.8	15.6	
Min Release Voltage 最小释放电压(VDC)	0.3	0.5	0.6	0.9	1.2	2.4	
Max Applicable Voltage 最大过载电压	70°C时额定电压的130%，23°C时额定电压的170%						

### ■ CONTACT DATA 触点参数

Contact Form 触点形式	1H/1Z
Contact Material 触点材料	Silver Alloy
Load 负载	Resistive load(COS Φ=1)
Contact Ratings 触点负载	NO: 40A 14VDC NC: 30A 14VDC
Max Switching Voltage 最大转换电压	60VDC
Max Switching Current 最大转换电流	40A
Max Switching Power 最大转换功率	560W
Contact Resistance 接触电阻	100m Ω Max                   at 6VDC 1A
Life Expectancy 寿命	Electrical 电气寿命: 100,000 Operations(at30Operations/minute) Mechanical 机械寿命: 10,000,000 Operations(at3000Operations/minute)

## ■ CHARACTERISTICS DATA 性能参数

Insulation Resistance绝缘阻值	100M $\Omega$ Min at 500VDC
Dielectric Strength Between Open Contacts触点间耐压	500VAC(for one minute)
Between Contacts and coil触点与线圈间耐压	500VAC(for one minute)
Operate Time吸合时间	< 6ms
Release Time释放时间	< 4ms
Temperature Range环境温度	-40 $^{\circ}$ C to +85 $^{\circ}$ C
Shock Resistance冲击	Operating Extremes动作极限: 20G
	Damage Limits破坏极限: 100G
Vibration Resistance振动	10-55Hz, 1.5mm
Max. switching frequency最大转换频率	Mechanical: 18,000operations/hr
	Electrical: 1,800operations/hr
Humidity湿度	40-85%
Weight重量	Approx 21g

## ■ ENGINEERING DATA 设计参数

最大允许环境温度曲线 ( $^{\circ}$ C)

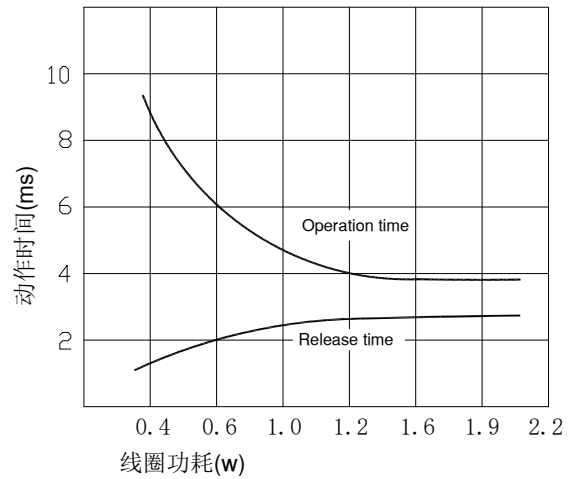
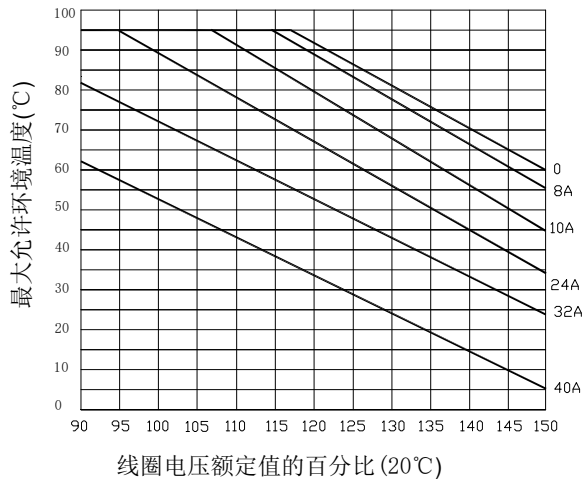

最大切换功率

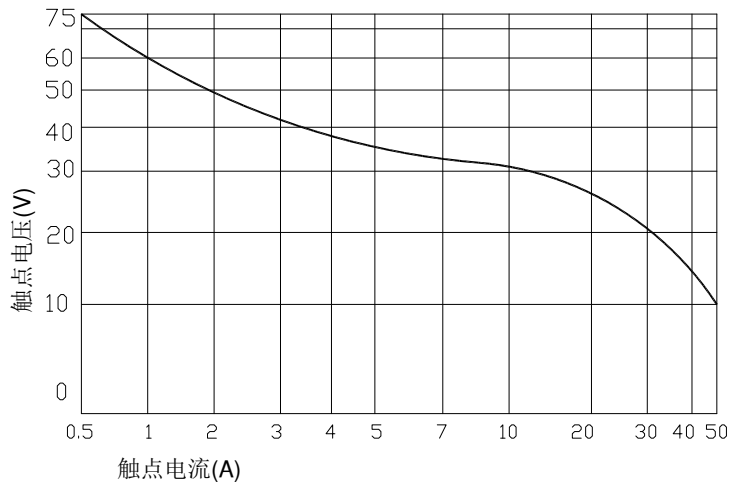

■ OVERALL AND MOUNTING DIMENSIONS 安装图

U. S. A open type

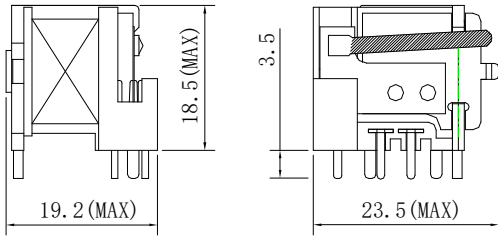

EUROPE open type

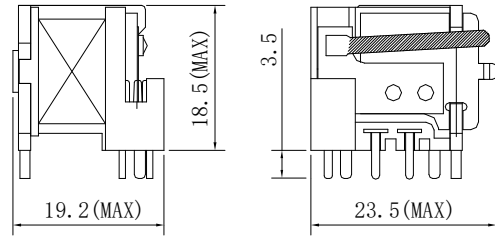

U. S. A sealed type

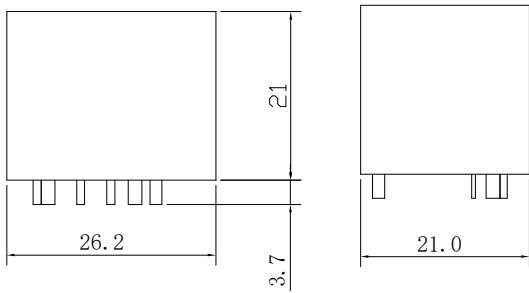

EUROPE sealed type

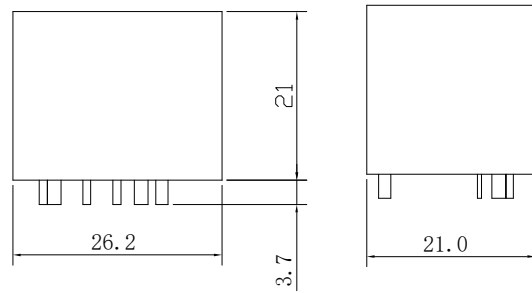

U. S. A

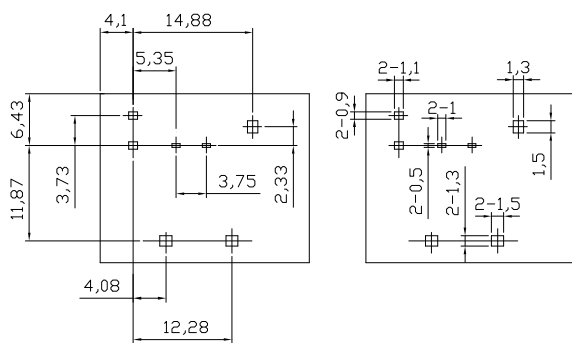

EUROPE

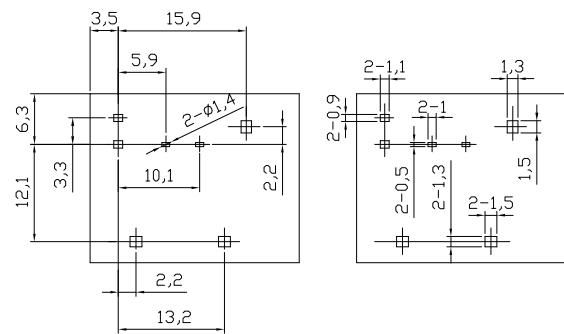

### U. S. A ( PCB layout )

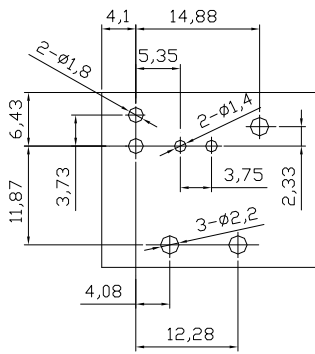

### EUROPE ( PCB layout )

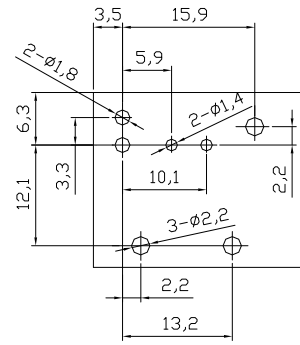

### U. S. A And EUROPE

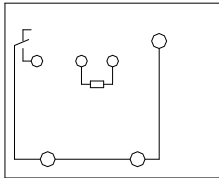

Form A

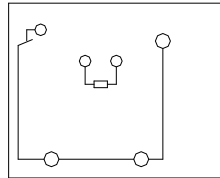

Form B

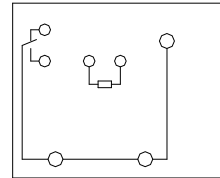

Form C

- 备注：1) 产品部分外形尺寸中未注尺寸公差：当外形尺寸 $\leq 1\text{mm}$ 时，公差为 $\pm 0.2\text{mm}$ ；当外形尺寸在 $1\sim 5\text{mm}$ 时，公差为 $\pm 0.3\text{mm}$ ；  
当外形尺寸 $> 5\text{mm}$ 时，公差为 $\pm 0.4\text{mm}$ 。  
2) 安装孔尺寸中未注尺寸公差均为 $\pm 0.1\text{mm}$ 。

### 声明：

本产品规格书仅供客户使用时参考，如有更改，恕不另行通知。